

Article number: 6160403030

Description: Welding hub for taper bush type MSB
for taper bush 3030

Measures

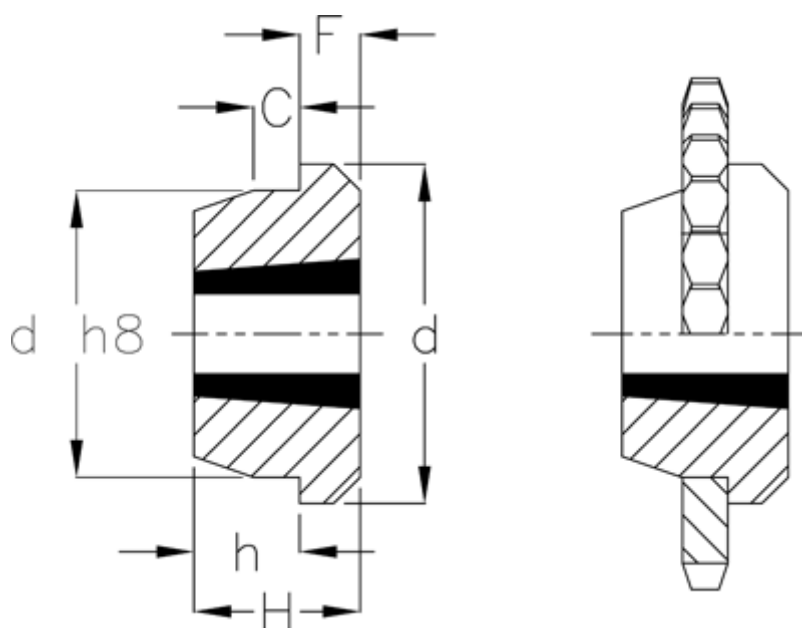

C	= 19
d	= 152
d H8	= 130
F	= 25
For taper bush = 3030	
H	= 76
h	= 51